

Assembly

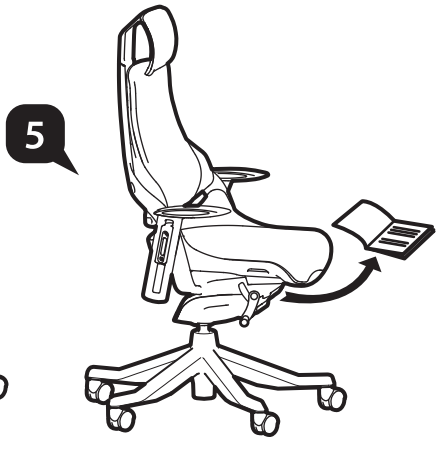

1

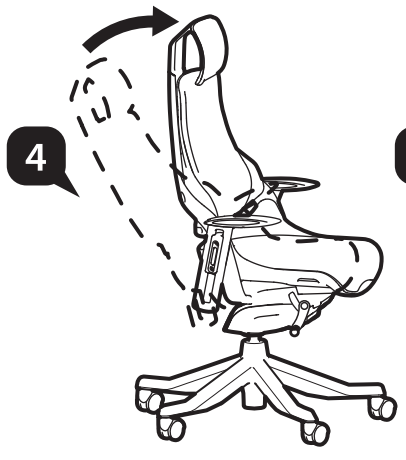
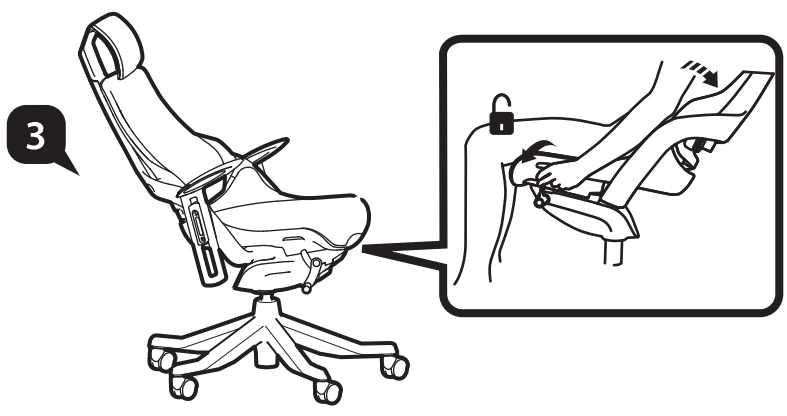
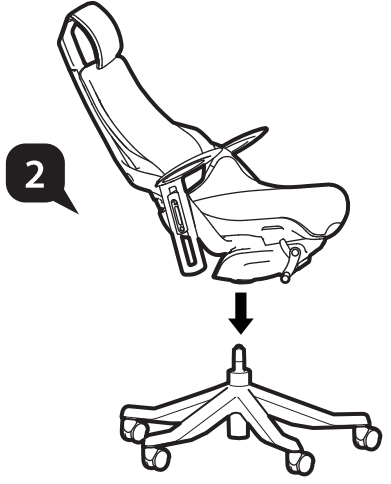
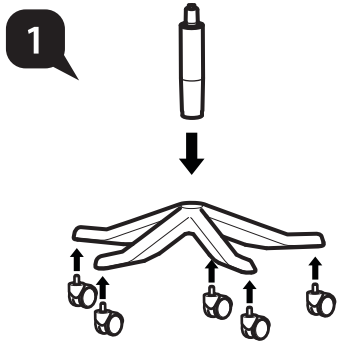
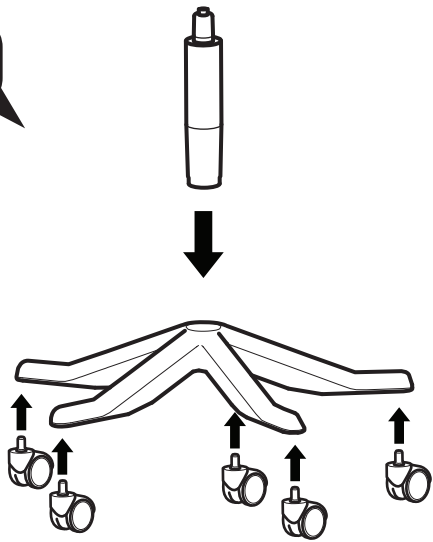

2

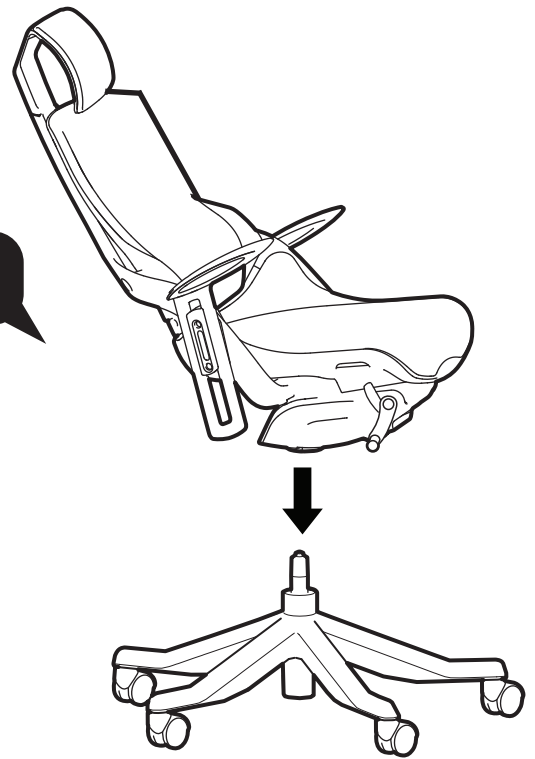

3

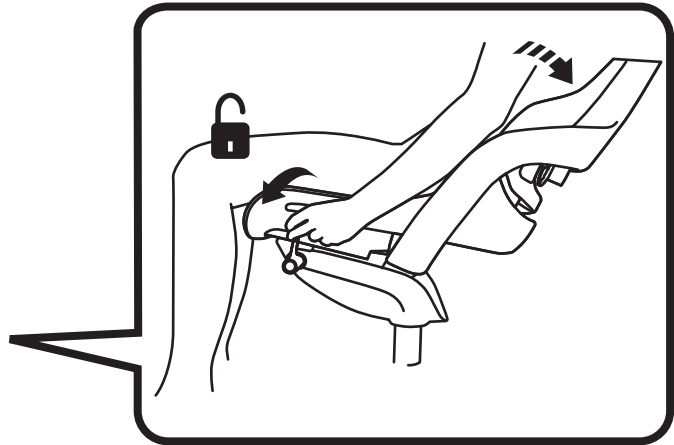
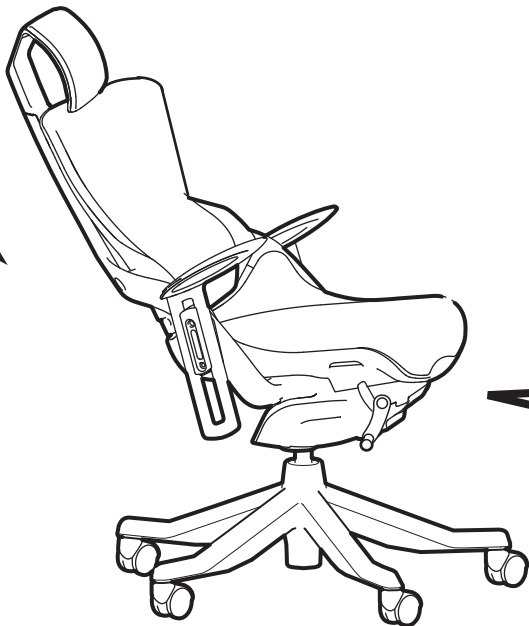

4

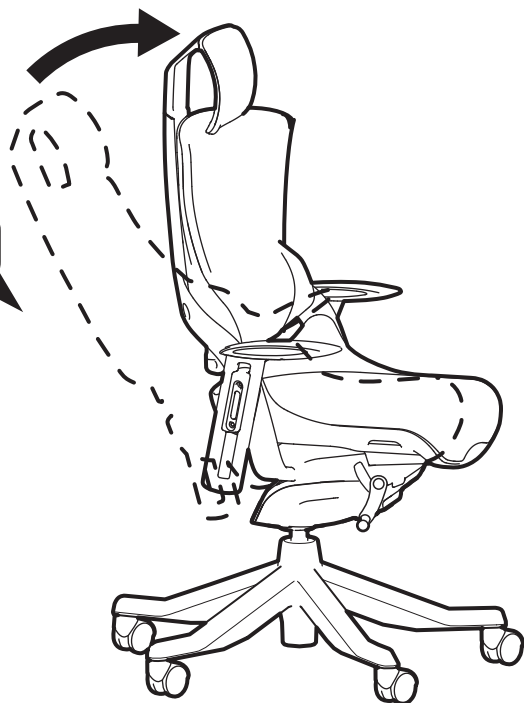

5

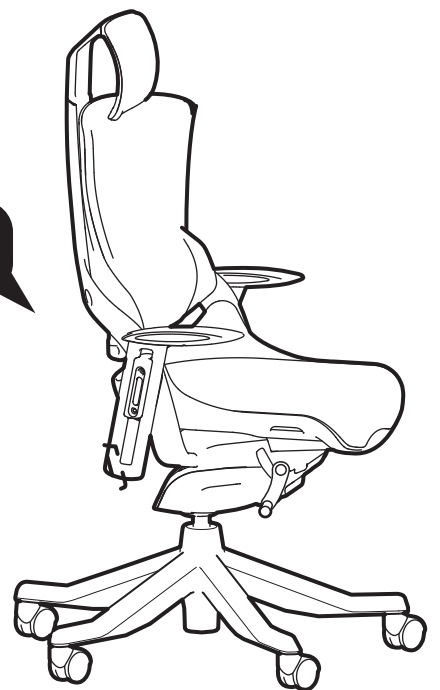

Assembly

1



5

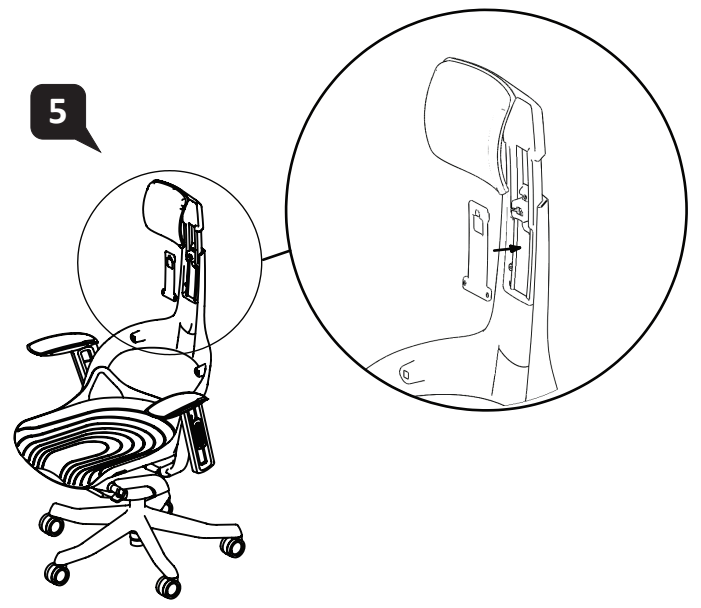

2

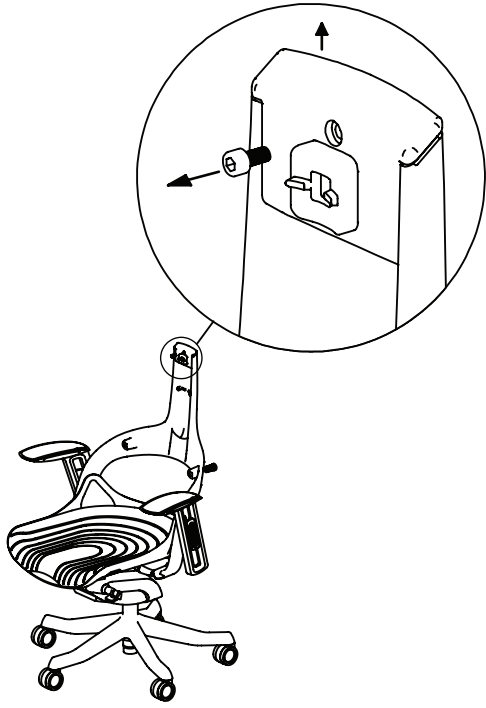

5

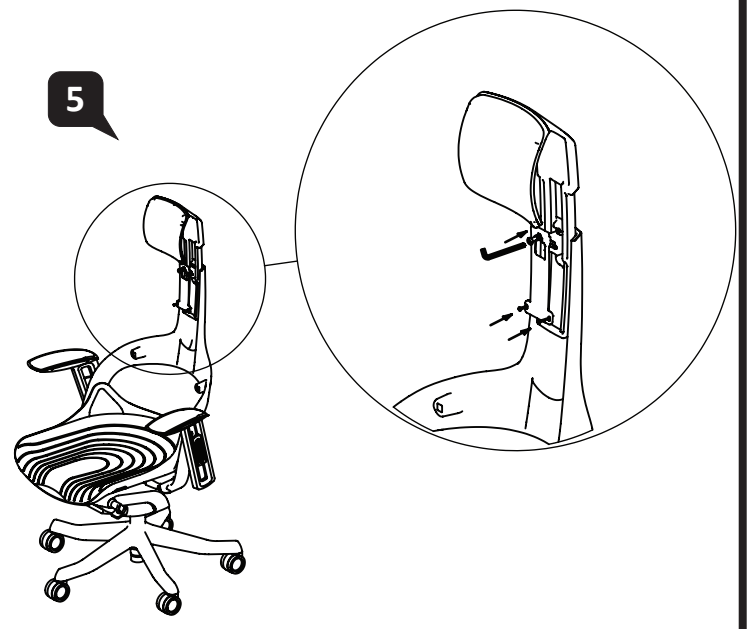

3

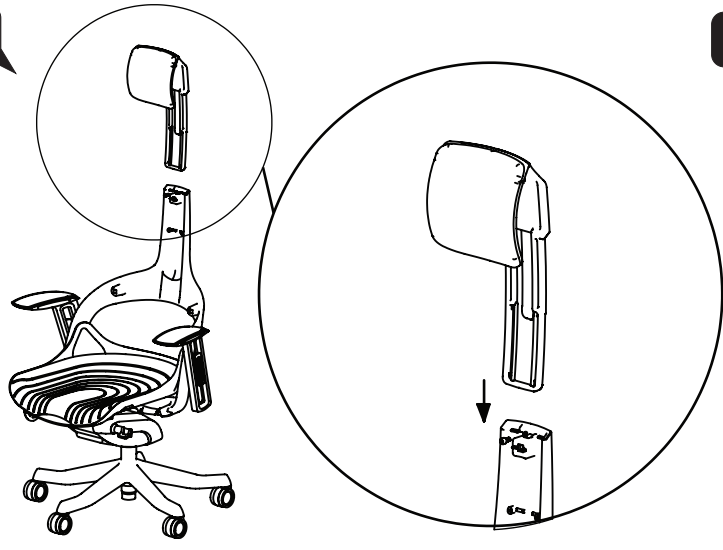

6

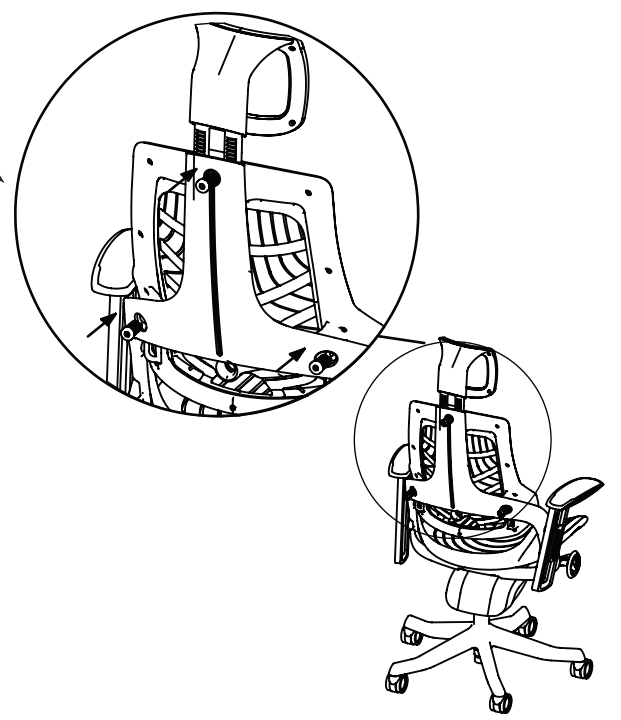

MERRYFAIR®

HEAD OFFICE & FACTORY

Merryfair Chair System Sdn Bhd

(Co. No. 86276-A)
No. 2, Jalan Koporat 1/KU9,
Taman Perindustrian Meru,
42200 Klang, Selangor D.E., Malaysia.

International Sales & Marketing

Tel: +603 3393 2888
Fax: +603 3393 2000
enquiry@merryfair.com

Domestic Sales & Marketing

Tel: +603 3393 6868
Fax: +603 3393 6888
domestic@merryfair.com

SHOWROOM OFFICE

Merryfair Marketing Sdn Bhd

(Co. No. 665054-V)
No. 82-84, Jalan 2/23A,
Jalan Genting Kelang,
53300 Kuala Lumpur, Malaysia.
Tel: +603 4149 8899
Fax: +603 4143 0113

REGIONAL OFFICE & SHOWROOM

美力菲(中国)家具有限公司

广东省佛山市顺德区容桂华口顺德高新区(容桂)华天路21号

Merryfair (China) Co.,Ltd

No. 21, Huatian Road, Shunde High Tech
Industrial Zone (Ronggui), Huakou Community,
Ronggui Subdistrict, Shunde District, Foshan City,
Guangdong, China 528306.
Tel : +86 757 2636 9861
Fax : +86 757 2881 9700
domestic@merryfair.com.cn

Merryfair (Singapore) Pte Ltd

33 Ubi Avenue 3, #01-52/53 Vertex,
Singapore 408868.
Tel : +65 6284 9098
Fax : +65 6284 9028
enquiry@merryfair.com.sg

Merryfair (Thailand) Co., Ltd

Thai Samut Building,
Ground Floor, 163 Surawongse Road,
Bangrak, Bangkok 10500, Thailand.
Tel : +66 2266 3855
Fax : +66 2266 3859
sales@merryfair.co.th

WAAU

user manual



Certificate No: 0049903

www.merryfair.com



Please read this manual and understand the chair's operations to get maximum benefit from it. *Wau* is available in different surface options, but their control and operations are the same. However, arms and head are optional and may be absent in your particular chair model.

Por favor, lea este manual para obtener las máximas ventajas de su silla. *Wau* está disponible en diferentes superficies, pero sus operaciones son las mismas. Sin embargo, los brazos y reposacabezas son opcionales y puede que no se incluyan en un modelo en particular de su silla.

Siete pregati di leggere questo manuale e capire le operazioni di utilizzo della sedia per avere il massimo beneficio dalla stessa. *Wau* è disponibile in differenti opzioni esterne, ma il loro controllo e operazioni sono le stesse. Comunque, braccioli e appoggiatesta sono opzionali e potrebbero essere assenti nel particolare modello di sedia scelto.

Bitte lesen sie dieses handbuch damit sie verstehen, den vorsitz operationen um den maximalen nutzen daraus zu ziehen. *Wau* ist in verschiedenen oberflächen optionen zur verfügung, aber ihre kontrolle und operationen sind die gleichen. Allerdings sind armllehne und den kopflehne optional und können in Ihrem speziellen stuhl modell nicht vorhanden.

请仔细阅读本手册，以更了解椅子的操作及功能，从而获益更深。此张椅子，无论是网背，布背或塑胶背，它们的控制和操作都是相同的。然而，扶手或头靠则可有或可无，视型号而定。

この取扱説明書をよくお読みになり、ご理解の上正しくご使用下さい。ワウ は仕様が異なりましても操作方法は共通です。お客様がお求めの仕様によりましては、アームレストやヘッドレストなどの装備がない場合があります。

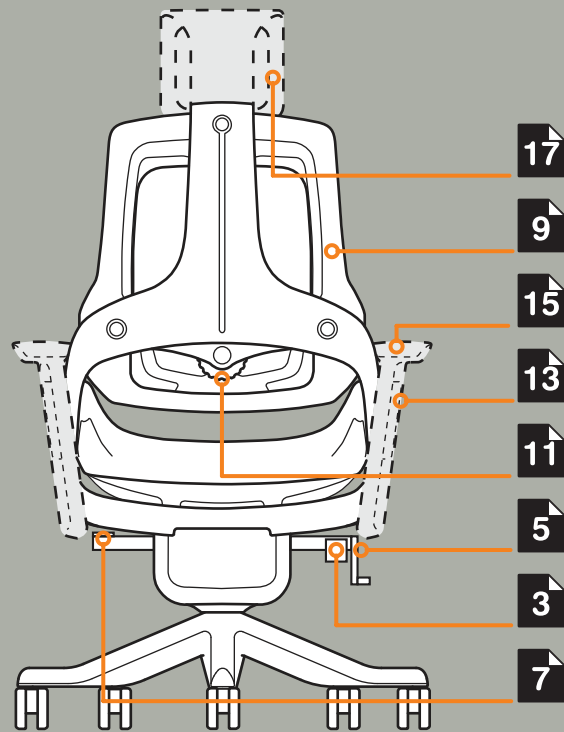

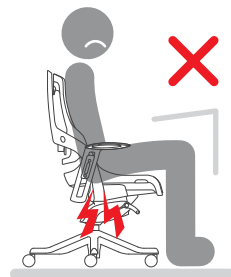
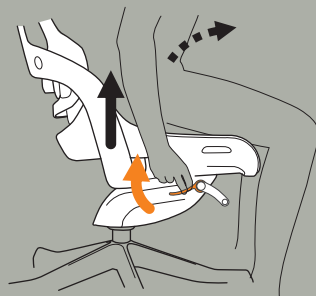
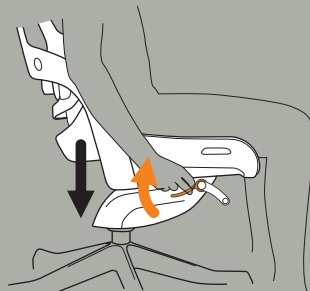

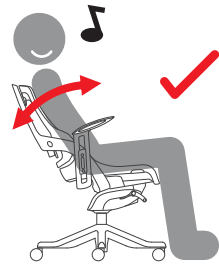
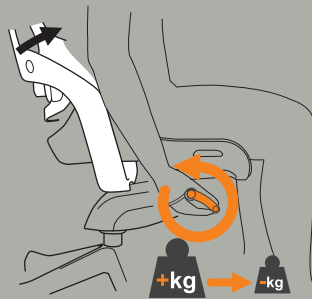
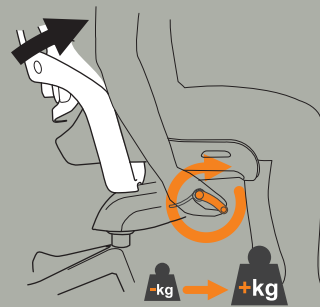

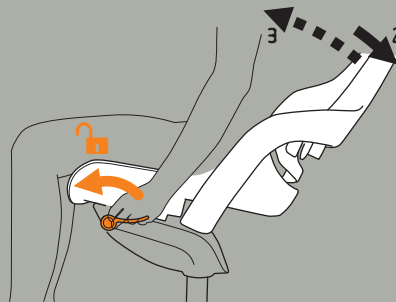
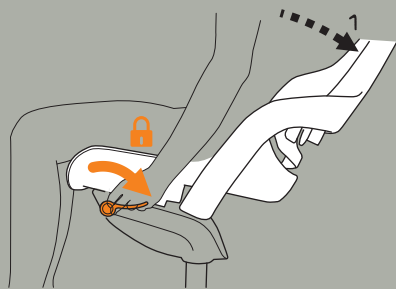

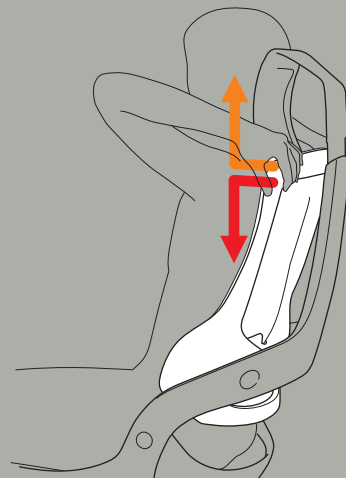

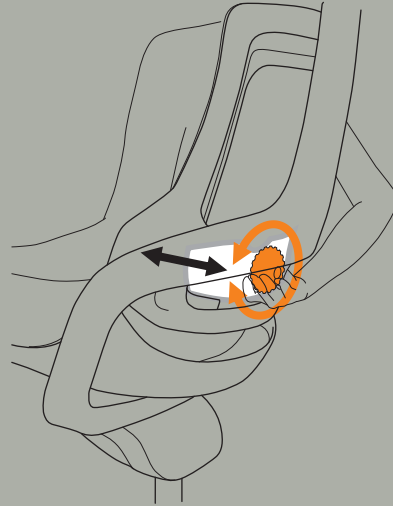

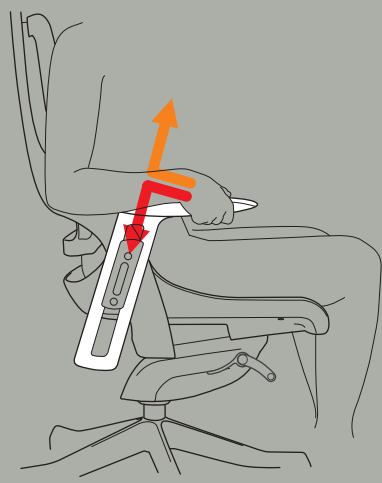



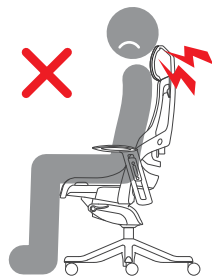
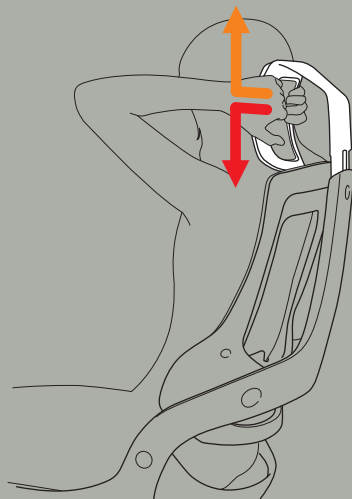

Assembly

